



FlameGuard[®] **CPVC FIRE SPRINKLER** **PIPING PRODUCTS**



TECHNICAL INFORMATION **WEIGHTS & DIMENSIONS**

November 2015
SUPERSEDES ALL PREVIOUS EDITIONS

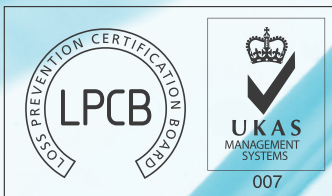

Assessed to ISO 9001: 2008
Certificate number 293

Visit our web site:
www.spearsmfg.com

FG-4-1115



FlameGuard® CPVC FIRE SPRINKLER PIPING PRODUCTS

The information contained in this section is based on current information and Product design at the time of publication and is subject to change without notification. Our ongoing commitment to product improvement may result in some variation. No representations, guarantees or warranties of any kind are made as to its accuracy, suitability for particular applications or results to be obtained therefrom. For verification of technical data or additional information not contained herein, please contact Spears® Technical Services Department [West Coast: (818) 364-1611—East Coast: (678) 985-1263].

General Information

RECOMMENDATIONS FOR INSTALLERS AND USERS:

Plastic piping systems should be **ENGINEERED, INSTALLED** and **OPERATED** in accordance with **ESTABLISHED DESIGN AND ENGINEERING STANDARDS AND PROCEDURES** for plastic piping systems. Suitability for the intended service application should be determined by the installer and/or user prior to installation of a plastic piping system. All Installation and maintenance personnel should be trained in the proper handling and installation requirements and precautions of plastic piping systems. **PRIOR TO ASSEMBLY, all piping system components should be inspected for damage or irregularities. Mating components should be checked to assure that tolerances and engagements are compatible. Do not use any components that appear irregular or do not fit properly. Contact the appropriate manufacturer of the component product in question to determine usability. Consult all applicable codes and regulations for compliance prior to installation.**

**Installation must be made in accordance with Spears® Manufacturing Company
FlameGuard® CPVC Fire Sprinkler Piping Products Installation Instructions - FG-3**

NOTE — Individual or group instruction in correct solvent welding procedures is available by contacting your local distributor or your servicing Spears® Regional Distribution Center.

SOLVENT CEMENT CONNECTIONS — Spears® Manufacturing Company recommends the use of Spears® FS-5 One Step solvent cement for joining Spears® products. Use of solvent cementing products not approved for CPVC fire sprinkler systems, or failure to follow installation instructions will automatically void the warranty.

THREADED CONNECTION — Spears® Manufacturing Company recommends the use of Spears® **BLUE 75™** Thread Sealant. This product has been tested by Spears® and the sealant manufacturer for compatibility with the Spears® CPVC fire sprinkler products. Consult the sprinkler head manufacturer before using this product. **WARNING: OTHER PIPE JOINT COMPOUNDS OR PASTES MAY CONTAIN SUBSTANCES THAT COULD CAUSE STRESS CRACKING IN THE CPVC OR OTHER FITTING COMPONENTS.** Care must be taken to avoid over torquing - generally 1 to 2 turns beyond finger tight is all that is required to make up a threaded connection. Factory testing has indicated 10-25 ft. lbs. of torque is adequate to obtain a leak free seal.

GASKET SEALED THREAD CONNECTIONS — This type of connection can only be made with Spears® TorqueSafe™, SofTorque™ or QuickTorque™ style Gasket Sealed Female Sprinkler Adapters. **DO NOT USE ANY TYPE OF THREAD SEALANT WHEN INSTALLING THIS TYPE OF ADAPTER.** Tape or paste may impair proper sealing and function. Testing has shown that hand tight until snug for the TorqueSafe™ adapter and finger tight plus 1-turn is all that is needed to seal this special connection. Sprinkler heads in these specialty fittings can then be additionally tightened clockwise to bring sprinkler frames into desired alignment without stressing the fitting. See specific adapter instructions in package for details.

GripLoc™ CONNECTIONS — This type of connection can only be made with Spears® GripLoc™ Couplings or Repair Couplings. **DO NOT USE ANY TYPE OF SOLVENT CEMENT OR SEALANT WHEN INSTALLING THIS TYPE OF CONNECTION.** Uses an internal stainless steel gripper ring with an internal elastomer gasket seal. Connection allows immediate system use. See specific instructions in package for details.

Installation Training Available - Contact Spears® Technical Services for Details

FlameGuard® Products must be installed in accordance with Spears® FlameGuard® CPVC Fire Sprinkler Piping Products Installation Instructions, National Fire Protection Association Standards 13, 13R, 13D, and in accordance with local codes. Code requirements and field conditions may differ. It is the responsibility of the installing contractor to insure that the product is suitable to meet these requirements.

Dimension Reference

G = (LAYING LENGTH) Intersection of center lines to bottom of socket/thread; 90° elbows, tees, crosses; ± 1/32 inch.

H = Intersection of center lines to face of fitting; 90° elbows tees, crosses; ± 1/32 inch.

J = Intersection of center lines to bottom of socket/thread; 45° elbows; ± 1/32 inch

L = Overall length of fittings; ± 1/16 inch.

M = Outside diameter of socket/thread hub; ± 1/16 inch.

N = Socket bottom to socket bottom; couplings; ± 1/16 inch.

Q = Width of flats; ± 1/16 inch.

W = Height of cap; ± 1/16 inch.

CPVC FIRE SPRINKLER PIPE SDR 13.5 (ASTM F 442)							
Part Number	Nominal Size		Average O.D.		Average I.D.		Approx. Weight Lbs./Ft.
	Inches	(mm)	Inches	(mm)	Inches	(mm)	
CP-007	3/4	(19.1)	1.050	(26.7)	.874	(22.5)	0.168
CP-010	1	(25.4)	1.315	(33.4)	1.101	(28.2)	0.262
CP-012	1-1/4	(31.8)	1.660	(42.2)	1.394	(35.6)	0.418
CP-015	1-1/2	(38.1)	1.900	(48.3)	1.598	(40.7)	0.548
CP-020	2	(50.8)	2.375	(60.3)	2.003	(50.9)	0.859
CP-025	2-1/2	(63.5)	2.875	(73.0)	2.423	(61.5)	1.257
CP-030	3	(76.2)	3.500	(88.9)	2.950	(75.0)	1.867

"Lead Free" low lead certification – unless other wise specified, all Spears® FlameGuard® fittings specified here-in are certified by NSF International to ANSI/NSF® Standard 61, Annex G and is in compliance with California's Health & Safety Code Section 116825 (commonly known as AB1953) and Vermont Act 193. Weighted average lead content <=0.25%. Spears® PVC and CPVC Pipe, Fittings and Valves have always been lead-free and Certified by NSF International for use in potable water systems. Spears® offers a wide range of lead-free specialty fittings and transition adapters for plumbing applications. However, certain brass threaded adapter fittings for applications that are not intended to convey water for human consumption through drinking or cooking are still produced and available.

FlameGuard® CPVC FIRE SPRINKLER PIPING PRODUCTS



SOCKET DIMENSIONS

SCH 40 - ASTM F438
SCH 80 - ASTM F439

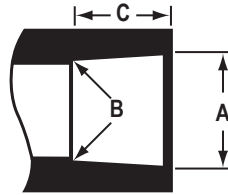

Size	Socket Entrance A	Socket Bottom B	Tolerance	SCH 40 Minimum Socket Length C	SCH 80 Minimum Socket Length C
3/4	1.058	1.046	± .004	.719	1.000
1	1.325	1.130	± .005	.875	1.125
1-1/4	1.670	1.655	± .005	.938	1.250
1-1/2	1.912	1.894	± .006	1.094	1.375
2	2.387	2.369	± .005	1.156	1.500
2-1/2	2.889	2.868	± .007	1.750	1.750
3	3.516	3.492	± .008	1.875	1.875

TEE

Socket x Socket x Socket

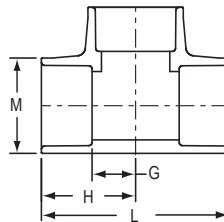

Part Number	Size	G	H	L	M	Approx. Wt. (Lbs.)
4201-007	3/4	9/16	1-1/2	2-31/32	1-5/16	.11
4201-010	1	7/8	1-13/16	3-5/8	1-5/8	.20
4201-012	1-1/4	15/32	2-3/32	4-7/32	2	.29
4201-015	1-1/2	1-5/32	2-9/16	5-3/32	2-11/32	.54
4201-020	2	1-13/32	2-15/16	5-7/8	2-7/8	.86
4201-025	2-1/2	1-23/32	3-1/2	7	3-15/32	1.62
4201-030	3	2-1/16	3-31/32	7-15/16	4-5/32	2.53

REDUCING TEE

Socket x Socket x Socket

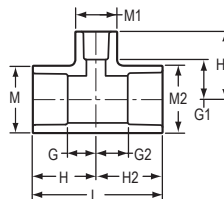

Part Number	Size	G	G1	G2	H	H1	H2	L	M	M1	M2	Approx. Wt. (Lbs.)
4201-102	3/4x3/4x1	3/4	3/4	3/4	1-11/16	1-25/32	1-11/16	3-13/32	1-5/16	1-21/32	1-5/16	.13
4201-125	1x3/4x3/4	23/32	7/8	23/32	1-25/32	1-13/16	1-21/32	3-7/16	1-19/32	1-11/32	1-5/16	.16
4201-126	1x3/4x1	23/32	23/32	3/4	1-27/32	1-27/32	1-3/4	3-19/32	1-5/8	1-5/8	1-5/16	.17
4201-131	1x1x3/4	11/16	13/16	11/16	1-13/16	1-13/16	1-13/16	3-5/8	1-5/8	1-5/16	1-5/8	.17
4201-157	1-1/4x1x3/4	11/16	1-1/32	11/16	1-15/16	2-1/32	1-13/16	3-25/32	2-3/32	1-13/32	1-23/32	.32



FlameGuard® CPVC FIRE SPRINKLER PIPING PRODUCTS

REDUCING TEE (continued)

Socket x Socket x Socket

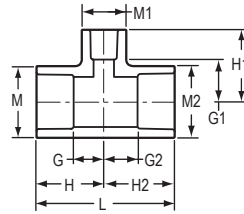

Part Number	Size	G	G1	G2	H	H1	H2	L	M	M1	M2	Approx. Wt. (Lbs.)
4201-158	1-1/4x1x1	27/32	29/32	25/32	2-1/16	2-1/32	1-29/32	3-15/16	1-31/32	1-5/8	1-5/8	.24
4201-159	1-1/4x1x1-1/4	31/32	31/32	31/32	2-7/32	2-7/32	2-3/32	4-11/32	2-1/8	2-1/8	1-23/32	.36
4201-167	1-1/4x1-1/4x3/4	21/32	1	21/32	1-29/32	2	1-29/32	3-13/16	2	1-5/16	2	.22
4201-168	1-1/4x1-1/4x1	13/16	1	13/16	2-1/16	2-1/8	2-1/16	4-1/8	1-31/32	1-21/32	1-31/32	.24
4201-169	1-1/4x1-1/4x1-1/2	1-1/8	15/16	1-1/8	2-3/8	2-11/32	2-3/8	4-3/4	2-3/32	2-11/32	2-3/32	.51
4201-201	1-1/2x1-1/4x3/4	11/16	1	1/4	2-1/16	2	1-15/16	4	2-5/16	1-3/8	2-1/16	.41
4201-202	1-1/2x1-1/4x1	27/32	1-1/32	1	2-7/32	2-5/32	2-1/4	4-15/32	2-5/16	1-11/16	2-1/16	.42
4201-210	1-1/2x1-1/2x3/4	11/16	1-1/32	11/16	2-1/16	2-1/32	2-1/16	4-5/32	2-11/32	1-13/32	2-11/32	.39
4201-211	1-1/2x1-1/2x1	13/16	1-3/32	13/16	2-3/16	2-1/4	2-3/16	4-3/8	2-11/32	1-3/4	2-11/32	.41
4201-212	1-1/2x1-1/2x1-1/4	1-1/32	1-3/32	1-1/32	2-13/32	2-11/32	2-13/32	4-13/16	2-11/32	2-1/8	2-11/32	.49
4201-213	1-1/2x1-1/2x2	1-9/32	1-5/32	1-9/32	2-21/32	2-21/32	2-21/32	5-11/32	2-11/32	2-29/32	2-11/32	.64
4201-248	2x2x3/4	11/16	1-13/32	11/16	2-7/32	2-7/16	2-7/32	4-7/16	2-27/32	1-3/8	2-27/32	.52
4201-249	2x2x1	27/32	1-13/32	27/32	2-11/32	2-9/16	2-11/32	4-23/32	2-7/8	1-3/4	2-7/8	.58
4201-250	2x2x1-1/4	1-1/32	1-11/32	1-1/32	2-17/32	2-19/32	2-17/32	5-3/32	2-7/8	2-3/32	2-7/8	.65
4201-251	2x2x1-1/2	1-5/32	1-7/16	1-5/32	2-11/16	2-13/32	2-11/16	5-3/8	2-7/8	2-13/32	2-7/8	.79
4201-289	2-1/2x2-1/2x1	27/32	1-23/32	27/32	2-5/8	2-27/32	2-5/8	5-1/4	3-17/32	1-23/32	3-17/32	1.01
4201-290	2-1/2x2-1/2x1-1/4	1-3/32	1-23/32	1-1/32	2-13/16	2-31/32	2-13/16	5-21/32	3-9/16	2-3/32	3-9/16	1.13
4201-291	2-1/2x2-1/2x1-1/2	1-3/16	1/2	1-3/16	2-15/16	1-7/8	2-15/16	5-7/8	3-15/32	2-11/32	3-15/32	1.26
4201-292	2-1/2x2-1/2x2	1-13/32	1-5/8	1-13/32	3-3/16	3-1/8	3-3/16	6-3/8	3-1/2	2-7/8	3-1/2	1.37
4201-335	3x3x1	7/8	1-15/16	7/8	2-3/4	3-1/16	2-3/4	5-15/32	4-3/16	1-23/32	4-3/16	1.26
4201-336*	3x3x1-1/4	1-3/8	1-3/4	1-3/8	3-5/16	3-1/2	3-5/16	6-5/8	4-1/8	2-7/8	4-1/8	1.94
4201-337	3x3x1-1/2	1-5/32	2-1/16	1-5/32	3-1/32	3-7/16	3-1/32	6-3/32	4-3/16	2-3/8	4-3/16	1.46
4201-338	3x3x2	1-7/16	1-13/16	1-7/16	3-5/16	3-5/16	3-5/16	6-19/32	4-3/16	2-7/8	4-3/16	1.69
4201-339	3x3x2-1/2	1-3/4	1-31/32	1-3/4	3-5/8	3-23/32	3-5/8	7-1/4	4-3/16	3-17/32	4-3/16	2.11

* Branch Outlet Sized with Bushing

TorqueSafe™ SPRINKLER HEAD TEE

Gasket Sealed Brass
Thread Insert Style

Socket x Socket x Gasket Fipt
With Elastomer Seal - Use NO Thread Sealant

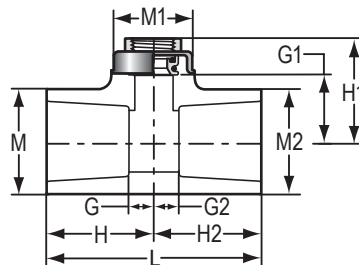

Part Number	Size	G	G1	G2	H	H1	H2	L	M	M1	M2	Approx. Wt. (Lbs.)
4202-101 G	3/4x3/4x1/2	7/16	1-3/16	7/16	1-7/16	1-7/16	1-17/32	2-29/32	1-3/8	1-3/8	1-3/8	.22
4202-124 G	1x3/4x1/2	7/16	1-11/32	9/16	1-9/16	1-11/16	1-9/16	3-1/8	1-11/16	1-3/8	1-3/8	.26
4202-130 G	1x1x1/2	7/16	1-11/32	7/16	1-9/16	1-11/16	1-9/16	3-1/8	1-23/32	1-3/8	1-23/32	.28
4202-131 G	1x1x3/4	17/32	15/16	17/32	1-11/16	1-5/8	1-11/16	3-11/32	1-23/32	1-9/16	1-23/32	.31
4202-166 G	1-1/4x1-1/4x1/2	7/16	1-5/8	7/16	1-11/16	1-15/16	1-11/16	3-3/8	2-1/16	1-3/8	2-1/16	.34
4202-209 G	1-1/2x1-1/2x1/2	1/2	1-13/16	1/2	1-7/8	2-3/32	1-7/8	3-3/4	2-11/32	1-3/8	2-11/32	.41
4202-247 G	2x2x1/2	1/2	2-1/16	1/2	2	2-11/32	2	4-1/32	2-27/32	1-3/8	2-27/32	.54

Not intended to convey or dispense water for human consumption through drinking or cooking



SPRINKLER HEAD TEE Brass Thread Insert Style

Socket x Socket x Fipt

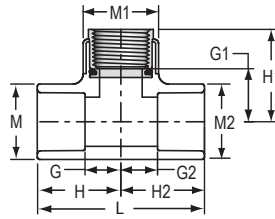

Part Number	Size	G	G1	G2	H	H1	H2	L	M	M1	M2	Approx. Wt. (Lbs.)
4202-010	1x1x1	21/31	1-1/8	21/31	1-25/32	1-29/32	1-25/32	3-19/32	1-23/32	1-23/32	1-23/32	.37

Not intended to convey or dispense water for human consumption through drinking or cooking

SofTorque™ SR REDUCING TEE Gasket Sealed Special Reinforced Plastic Thread Style

Socket x Socket x SR Fipt

With Elastomer Seal - Use NO Thread Sealant

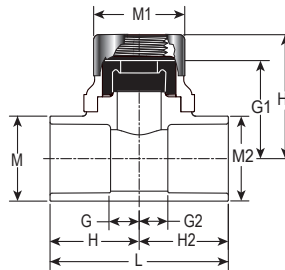

Part Number	Size	G	G1	G2	H	H1	H2	L	M	M1	M2	Approx. Wt. (Lbs.)
4202-101GSR	3/4x3/4x1/2	7/16	1-1/2	7/16	1-3/8	1-7/8	1-3/8	2-3/4	1-5/16	1-3/8	1-5/16	.16
4202-130GSR	1x1x1/2	7/16	1-5/8	7/16	1-1/2	2	1-1/2	3	1-5/8	1-3/8	1-5/8	.20

SPRINKLER REDUCING HEAD TEE Brass Thread Insert Style

Socket x Socket x Fipt

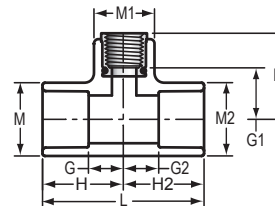

Part Number	Size	G	G1	G2	H	H1	H2	L	M	M1	M2	Approx. Wt. (Lbs.)
4202-101	3/4x3/4x1/2	7/16	1-1/16	7/16	1-15/32	1-5/8	1-15/32	2-29/32	1-13/32	1-3/16	1-13/32	.20
4202-124	1x3/4x1/2	7/16	1-11/32	9/16	1-9/16	1-11/16	1-9/16	3-1/8	1-11/16	1-3/8	1-3/8	.26
4202-130	1x1x1/2	7/16	1-7/32	7/16	1-9/16	1-25/32	1-9/16	3-1/8	1-3/4	1-3/16	1-3/4	.26
4202-156	1-1/4x1x1/2	7/16	1-7/16	9/16	1-11/16	2-1/32	1-11/16	3-3/8	2-3/32	1-3/16	1-23/32	.30
4202-166	1-1/4x1-1/4x1/2	7/16	1-15/32	7/16	1-11/16	2-1/32	1-11/16	3-3/8	2-3/32	1-3/16	2-3/32	.31
4202-199	1-1/2x1-1/4x1/2	1/2	1-5/8	9/16	1-7/8	2-3/16	1-13/16	3-11/16	2-11/32	1-3/16	2-1/16	.37
4202-209	1-1/2x1-1/2x1/2	1/2	1-5/8	1/2	1-7/8	2-3/16	1-7/8	3-3/4	2-11/32	1-3/16	2-11/32	.38
4202-237	2x1-1/2x1/2	1/2	1-27/32	17/32	2	2-7/16	1-29/32	3-15/16	2-7/8	1-3/16	2-11/32	.47
4202-247	2x2x1/2	1/2	1-7/8	1/2	2	2-7/16	2	4-1/32	2-27/32	1-3/16	2-27/32	.50

Not intended to convey or dispense water for human consumption through drinking or cooking



FlameGuard® CPVC FIRE SPRINKLER PIPING PRODUCTS

SPRINKLER HEAD TEE

**Special Reinforced
Plastic Thread Style**

Socket x Socket x SR Fipt

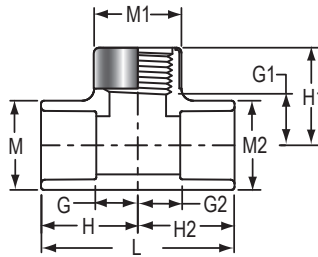

Part Number	Size	G	G1	G2	H	H1	H2	L	M	M1	M2	Approx. Wt. (Lbs.)
4202-010SR	1x1x1	21/32	3/4	21/32	1-25/32	1-5/8	1-25/32	3-19/32	1-23/32	1-11/16	1-23/32	.26

SPRINKLER REDUCING HEAD TEE

**Special Reinforced
Plastic Thread Style**

Socket x Socket x SR Fipt

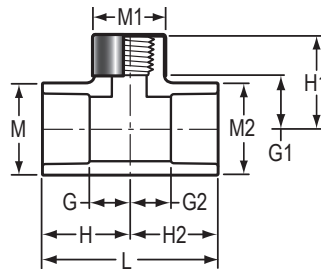

Part Number	Size	G	G1	G2	H	H1	H2	L	M	M1	M2	Approx. Wt. (Lbs.)
4202-101SR	3/4x3/4x1/2	19/32	25/32	19/32	1-19/32	1-7/16	1-19/32	3-7/32	1-13/32	1-3/16	1-13/32	.15
4202-124SR	1x3/4x1/2	7/16	29/32	9/16	1-19/32	1-5/8	1-9/16	3-5/32	1-23/32	1-3/16	1-17/32	.19
4202-130SR	1x1x1/2	7/16	29/32	7/16	1-9/16	1-5/8	1-9/16	3-1/8	1-23/32	1-3/16	1-23/32	.20
4202-156SR	1-1/4x1x1/2	15/32	1-5/32	19/32	1-23/32	1-7/8	1-23/32	3-13/32	2-3/32	1-3/16	1-23/32	.26
4202-166SR	1-1/4x1-1/4x1/2	7/16	1-1/8	7/16	1-11/16	1-27/32	1-11/16	3-3/8	2-3/32	1-3/16	2-3/32	.26
4202-168SR	1-1/4x1-1/4x1	27/32	1-1/32	27/32	2-3/32	1-29/32	2-3/32	4-7/32	2-3/32	1-11/16	2-3/32	.34
4202-199SR	1-1/2x1-1/4x1/2	9/16	1-9/32	17/32	1-15/16	2	1-25/32	3-23/32	2-11/32	1-3/16	2-3/32	.33
4202-209SR	1-1/2x1-1/2x1/2	1/2	1-1/4	1/2	1-7/8	1-31/32	1-7/8	3-3/4	2-11/32	1-3/16	2-11/32	.35
4202-211SR	1-1/2x1-1/2x1	27/32	1-7/32	27/32	2-7/32	2-1/8	2-7/32	4-15/32	2-11/32	1-23/32	2-11/32	.44
4202-237SR	2x1-1/2x1/2	23/32	1-9/16	3/8	2-7/32	2-9/32	1-3/4	3-31/32	2-7/8	1-3/16	2-11/32	.45
4202-247SR	2x2x1/2	1/2	31/32	1/2	2	1-11/16	19/32	4	2-7/8	1-3/16	2-7/8	.48
4202-287SR	2-1/2x2-1/2x1/2	17/32	1-3/4	17/32	2-9/32	2-1/2	2-9/32	4-19/32	3-1/2	1-7/32	3-1/2	.78

SOFTORQUE™

SR SPRINKLER HEAD TEE

**Gasket Sealed Special
Reinforced Plastic Thread Style**

Socket x SR Fipt x Socket

Stainless Steel Collar With Elastomer Seal - Use
NO Thread Sealant

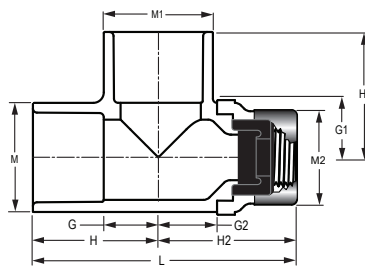

Part Number	Size	G	G1	G2	H	H1	H2	L	M	M1	M2	Approx. Wt. (Lbs.)
4203-122GSR	1x1/2x1	13/16	13/16	1-1/2	1-27/32	1-27/32	1-31/32	3-13/16	1-5/8	1-5/8	1-3/8	.22



TorqueSafe™ SPRINKLER HEAD TEE

Gasket Sealed

Brass Thread Insert Style

Socket x Gasket Fipt x Socket

With Elastomer Seal - Use NO Thread Sealant

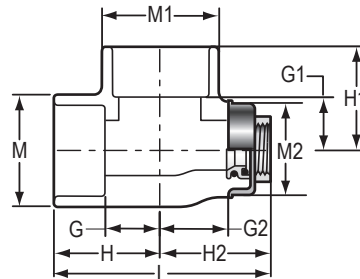

Part Number	Size	G	G1	G2	H	H1	H2	L	M	M1	M2	Approx. Wt. (Lbs.)
4203-122 G	1x1/2x1	19/32	13/16	1-13/32	1-19/32	1-27/32	1-3/4	3-11/32	1-5/8	1-5/8	1-3/8	.25

Not intended to convey or dispense water for human consumption through drinking or cooking

SPRINKLER HEAD TEE Brass Thread Insert Style

Socket x Fipt x Socket

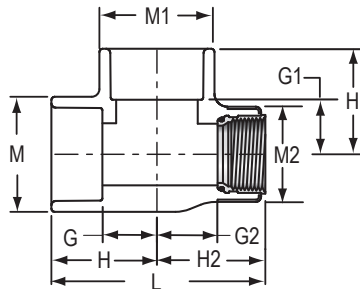

Part Number	Size	G	G1	G2	H	H1	H2	L	M	M1	M2	Approx. Wt. (Lbs.)
4203-122	1x1/2x1	23/32	3/4	1-1/4	1-5/8	1-5/8	1-15/16	3-1/2	1-23/32	1-23/32	1-3/16	.25

Not intended to convey or dispense water for human consumption through drinking or cooking

SPRINKLER HEAD TEE Special Reinforced Plastic Thread Style

Socket x SR Fipt x Socket

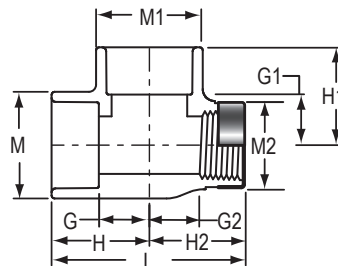

Part Number	Size	G	G1	G2	H	H1	H2	L	M	M1	M2	Approx. Wt. (Lbs.)
4203-122SR	1x1/2x1	27/32	23/32	1-3/32	1-23/32	1-5/8	1-25/32	3-13/32	1-3/4	1-3/4	1-3/16	.21



FlameGuard® CPVC FIRE SPRINKLER PIPING PRODUCTS

STREET TEE

Spigot x Socket x Socket

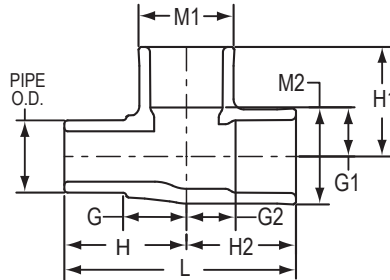

Part Number	Size	G	G1	G2	H	H1	H2	L	M1	M2	Approx. Wt. (Lbs.)
4244-007	3/4	13/16	27/32	27/32	1-13/16	1-7/8	1-7/8	3-5/8	1-13/32	1-13/32	.16
4244-010	1	1-5/32	1-1/32	1-1/32	2-1/8	1-29/32	1-29/32	4-3/16	1-3/4	1-3/4	.27
4244-012	1-1/4	1-1/4	1	1	2-7/16	2-9/32	2-9/32	4-27/32	2-3/32	2-3/32	.42
4244-015	1-1/2	1-13/16	1-1/8	1-1/8	2-7/8	2-9/16	2-9/16	5-11/32	2-11/32	2-11/32	.56
4244-020	2	1-23/32	1-7/16	1-13/32	3-1/4	2-15/16	2-15/16	6-5/32	2-7/8	2-7/8	.84

90° ELBOW

Socket x Socket

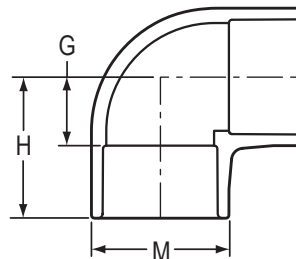

Part Number	Size	G	H	M	Approx. Wt. (Lbs.)
4206-007	3/4	9/16	1-1/2	1-5/16	.07
4206-010	1	3/4	1-5/8	1-5/8	.11
4206-012	1-1/4	15/16	2-3/16	2	.22
4206-015	1-1/2	1-5/32	2-17/32	2-3/8	.41
4206-020	2	1-13/32	2-29/32	2-7/8	.62
4206-025	2-1/2	1-15/32	3-3/8	3-1/2	1.15
4206-030	3	1-5/32	3-3/32	4-3/16	1.83



SIDE OUTLET ELBOW

Socket x Socket x Socket

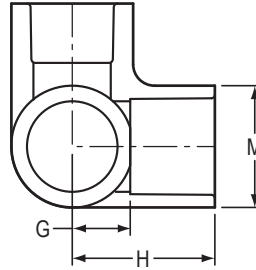

Part Number	Size	G	H	M	Approx. Wt. (Lbs.)
4213-007	3/4	27/32	1-19/32	1-5/16	.09
4213-010	1	13/16	1-7/8	1-5/8	.18

REDUCING 90° ELBOW

Socket x Socket

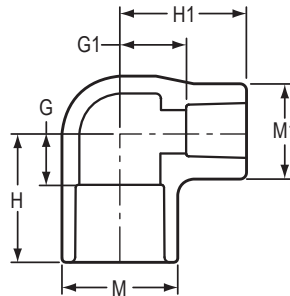

Part Number	Size	G	G1	H	H1	M	M1	Approx. Wt. (Lbs.)
4206-131	1x3/4	21/32	13/16	1-25/32	1-13/16	1-19/32	1-5/16	.11

TorqueSafe™ 90° SPRINKLER HEAD ELBOW

Gasket Sealed Brass Thread Insert Style

Socket x Gasket Fipt

With Elastomer Seal - Use NO Thread Sealant

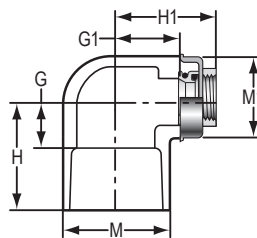

Part Number	Size	G	G1	H	H1	M	M1	Approx. Wt. (Lbs.)
4207-101 G	3/4x1/2	9/16	1-7/32	1-13/32	1-17/32	1-13/32	1-3/8	.19
4207-130 G	1x1/2	7/16	1-3/16	1-9/16	1-11/16	1-23/32	1-3/8	.23
4207-166 G	1-1/4x1/2	15/32	1-19/32	1-15/16	1-11/16	2-3/32	1-3/8	.25

Not intended to convey or dispense water for human consumption through drinking or cooking



FlameGuard® CPVC FIRE SPRINKLER PIPING PRODUCTS

SPRINKLER HEAD 90° ELBOW

Brass Thread Insert Style

Socket x Fipt

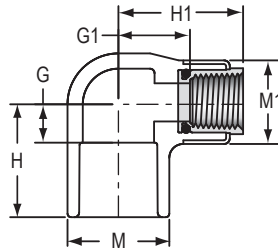

Part Number	Size	G	G1	H	H1	M	M1	Approx. Wt. (Lbs.)
4207-101	3/4x1/2	1/2	1-3/32	1-1/2	1-5/8	1-13/32	1-3/16	.17
4207-130	1x1/2	7/16	1-7/32	1-19/32	1-25/32	1-23/32	1-3/16	.21
4207-131	1x3/4	17/32	1-11/32	1-21/32	1-31/32	1-23/32	1-3/8	.25
4207-166	1-1/4x1/2	15/32	1-17/32	1-11/16	1-15/16	2-3/32	1-17/32	.33

Not intended to convey or dispense water for human consumption through drinking or cooking

SofTorque™ SR 90° ELBOW SPRINKLER HEAD ADAPTER

Gasket Sealed Special Reinforced Plastic Thread Style

Socket x SR Fipt

With Elastomer Seal - Use NO Thread Sealant

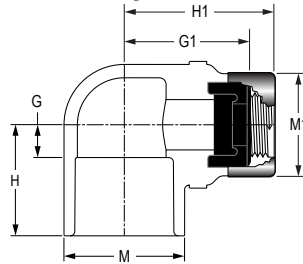

Part Number	Size	G	G1	H	H1	M	M1	Approx. Wt. (Lbs.)
4207-101GSR	3/4x1/2	7/16	1-17/32	1-3/8	1-27/32	1-11/32	1-3/8	.17
4207-130GSR	1x1/2	7/16	1-11/16	1-1/2	2	1-21/32	1-3/8	.19
4207-166GSR	1-1/4x1/2	7/16	1-7/8	1-11/16	2-7/32	2	1-3/8	.22

SPRINKLER HEAD 90° ELBOW

Special Reinforced Plastic Thread Style

Socket x SR Fipt

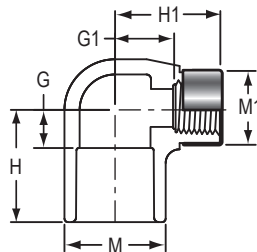

Part Number	Size	G	G1	H	H1	M	M1	Approx. Wt. (Lbs.)
4207-101SR	3/4x1/2	11/32	13/16	1-15/32	1-1/2	1-13/32	1-3/16	.14
4207-130SR	1x1/2	7/16	7/8	1-9/16	1-5/8	1-23/32	1-3/8	.20
4207-131SR	1x3/4	1/2	7/8	1-5/8	1-9/16	1-23/32	1-3/8	.16
4207-166SR	1-1/4x1/2	13/32	1-1/32	1-21/32	1-23/32	2-3/32	1-7/32	.19



90° STREET ELBOW

Spigot x Socket

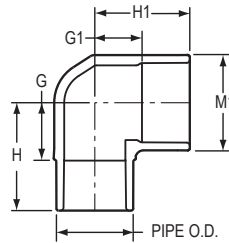

Part Number	Size	G	G1	H	H1	M1	Approx. Wt. (Lbs.)
4209-007	3/4	29/32	19/32	1-15/16	1-11/16	1-13/32	.12
4209-010	1	1-9/32	23/32	2-13/32	1-27/32	1-3/4	.21
4209-012	1-1/4	1-9/16	27/32	2-13/16	2-3/32	2-3/32	.32
4209-015	1-1/2	1-15/32	1-3/16	2-27/32	2-9/16	2-11/32	.42
4209-020	2	1-23/32	1-3/8	3-7/32	2-15/16	2-27/32	.65

22-1/2° ELBOW

Socket x Socket

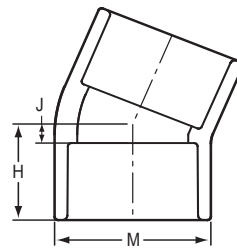

Part Number	Size	H	J	M	Approx. Wt. (Lbs.)
4216-007	3/4	1-3/16	7/32	1-13/32	.09
4216-010	1	1-3/8	9/32	1-25/32	.14
4216-012	1-1/4	1-1/2	5/16	2-3/32	.20
4216-015	1-1/2	1-7/16	13/32	1-3/8	.19
4216-020	2	1-7/8	3/8	2-27/32	.43
4216-030	3	2-3/8	1/2	4-5/32	1.00

22-1/2° STREET ELBOW

Spigot x Socket

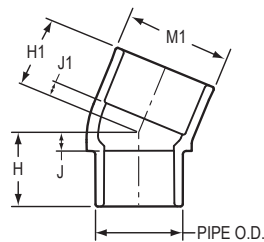

Part Number	Size	H	H1	J	J1	M1	Approx. Wt. (Lbs.)
4242-007	3/4	1-1/4	1-1/2	1/4	1/2	1-3/8	.08
4242-010	1	1-7/16	1-11/32	5/16	7/32	1-23/32	.14
4242-012	1-1/4	1-9/16	1-25/32	17/32	11/16	2-1/16	.21
4242-015	1-1/2	1-13/32	1-23/32	1/2	11/32	2-11/32	.28
4242-020	2	1-29/32	2-1/8	7/32	5/8	2-7/8	.42
4242-025	2-1/2	2-1/8	2-1/4	13/32	1/2	3-1/2	.68
4242-030	3	2-13/32	2-13/32	9/16	17/32	4-5/32	.99



FlameGuard® CPVC FIRE SPRINKLER PIPING PRODUCTS

45° ELBOW

Socket x Socket

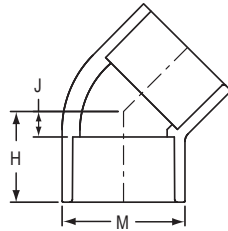

Part Number	Size	H	J	M	Approx. Wt. (Lbs.)
4217-007	3/4	1-5/16	5/16	1-5/16	.07
4217-010	1	1-13/32	3/8	1-5/8	.11
4217-012	1-1/4	1-5/8	3/8	2-5/32	.21
4217-015	1-1/2	1-27/32	15/32	2-11/32	.32
4217-020	2	2-1/8	21/32	2-7/8	.48
4217-025	2-1/2	2-17/32	3/4	3-1/2	.88
4217-030	3	2-29/32	29/32	4-5/32	1.17

CROSS

Socket x Socket x Socket x Socket

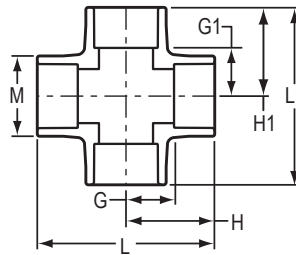

Part Number	Size	G	G1	H	H1	L	L1	M	Approx. Wt. (Lbs.)
4220-007	3/4	5/8	5/8	1-21/32	1-21/32	3-5/16	3-5/16	1-13/32	.22
4220-010	1	3/4	3/4	1-5/8	1-5/8	3-1/4	3-1/4	1-23/32	.20
4220-012	1-1/4	1-1/8	1-1/8	2-3/8	2-3/8	4-3/4	4-3/4	2-3/32	.63
4220-015	1-1/2	1-7/32	1-7/32	2-5/8	2-5/8	5-7/32	5-7/32	2-3/8	.80
4220-020	2	1-1/2	1-1/2	3	3	6	6	3	1.43
4220-025	2-1/2	1-11/16	1-11/16	3-7/16	3-7/16	6-7/8	6-7/8	3-17/32	2.16
4220-030	3	2-3/32	2-3/32	3-31/32	3-31/32	7-15/16	7-15/16	4-7/16	3.37



45° STREET ELBOW

Spigot x Socket

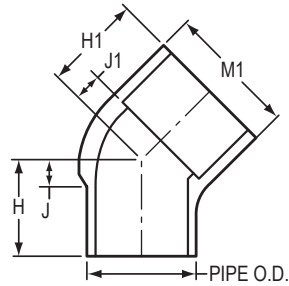

Part Number	Size	H	H1	J	J1	M1	Approx. Wt. (Lbs.)
4227-010	1	1-1/2	1-5/16	1/2	1/4	1-5/8	.10
4227-012	1-1/4	1-25/32	1-9/16	9/16	11/32	1-31/32	.15
4227-015	1-1/2	2-1/32	2-1/8	19/32	25/32	2-11/32	.29
4227-020	2	2-5/16	1-15/16	25/32	13/32	2-7/8	.44

REDUCING CROSS

Socket x Socket x Socket x Socket

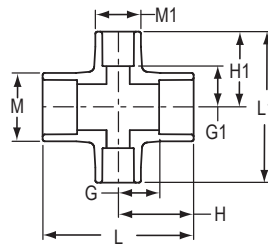

Part Number	Size	G	G1	H	H1	L	L1	M	M1	Approx. Wt. (Lbs.)
4220-131	1x3/4	23/32	5/8	1-5/8	1-5/8	3-1/4	3-1/4	1-7/8	1-1/2	.31
4220-167	1-1/4x3/4	1-1/16	23/32	2-1/16	1-31/32	4-3/32	3-31/32	2-1/16	1-13/32	.35
4220-210	1-1/2x3/4	11/16	1-5/32	2-3/32	2-3/16	4-3/16	4-11/32	2-3/8	1-13/32	.42
4220-248	2x3/4	11/16	1-7/16	2-7/32	2-7/16	4-13/32	4-7/8	2-29/32	1-13/32	.56
4220-289	2-1/2x1	29/32	1-3/4	2-11/16	2-7/8	5-11/32	5-3/4	3-1/2	1-3/4	.98

COUPLING

Socket x Socket

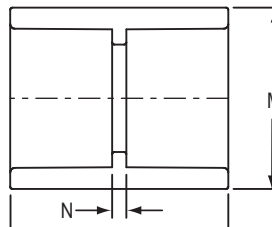

Part Number	Size	L	M	N	Approx. Wt. (Lbs.)
4229-007	3/4	2-1/8	1-5/16	3/16	.05
4229-010	1	2-3/16	1-5/8	3/32	.08
4229-012	1-1/4	2-19/32	2	3/32	.13
4229-015	1-1/2	2-7/8	2-11/32	3/32	.22
4229-020	2	3-1/8	2-7/8	1/8	.33
4229-025	2-1/2	3-11/16	3-15/32	3/16	.48
4229-030	3	4	4-3/16	1/4	.89



FlameGuard® CPVC FIRE SPRINKLER PIPING PRODUCTS

REDUCER COUPLING

Socket x Socket

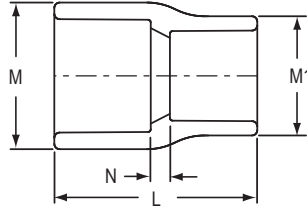

Part Number	Size	L	M	M1	N	Approx. Wt. (Lbs.)
4229-131	1x3/4	2-3/8	1-23/32	1-13/32	7/32	.10
4229-167	1-1/4x3/4	2-19/32	2-3/32	1-5/8	11/32	.17
4229-168	1-1/4x1	2-11/16	2-3/32	1-23/32	5/16	.18
4229-210	1-1/2x3/4	2-13/16	2-11/32	1-13/32	15/32	.19
4229-211	1-1/2x1	2-7/8	2-11/32	1-15/16	3/8	.24
4229-212	1-1/2x1-1/4	2-13/16	2-13/32	2-1/8	5/32	.23
4229-248	2x3/4	3-3/16	2-7/8	1-7/16	23/32	.32
4229-249	2x1	3-1/8	2-7/8	1-23/32	1/2	.31
4229-250	2x1-1/4	3-3/16	2-7/8	2-1/8	17/32	.33
4229-251	2x1-1/2	3-3/16	2-27/32	2-11/32	9/32	.31
4229-291	2-1/2x1-1/2	3-23/32	3-15/32	2-11/32	21/32	.51
4229-292	2-1/2x2	3-21/32	3-1/2	2-7/8	13/32	.52
4229-337	3x1-1/2	3-1/2	4-3/16	2-3/8	7/32	.71
4229-339	3x2-1/2	3-27/32	4-3/16	3-1/2	3/16	.80

GripLoc™ COUPLING - LEAD FREE

w/EPDM O-Ring Seals

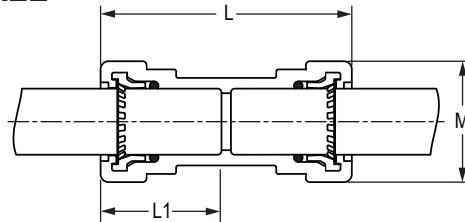

**175 psi Maximum
Internal Pressure @ 150°F**

WARNING: DO NOT INSERT FINGERS.

Part Number	Size	L	M1	N	Approx. Wt. (Lbs.)
GL4229-007	3/4	4	1-15/16	1-29/32	.25
GL4229-010	1	4-5/32	2	2-1/4	.34



GROOVED COUPLING ADAPTER

Groove x Socket

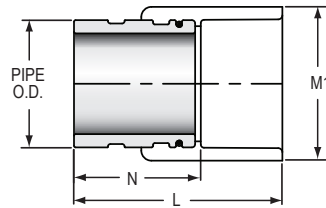

Part Number	Size	L	M1	N	Approx. Wt. (Lbs.)
4233-012	1-1/4	3-5/8	2-3/32	2-11/32	.72
4233-015	1-1/2	3-3/4	2-11/32	2-11/32	.83
4233-020	2	3-27/32	2-27/32	2-11/32	1.27
4233-025	2-1/2	4-3/16	3-15/32	2-7/16	2.02
4233-030	3	4-5/16	4-1/8	2-7/16	2.76

Not intended to convey or dispense water for human consumption through drinking or cooking

FEMALE ADAPTER

Brass Thread Insert Style

Socket x Fipt

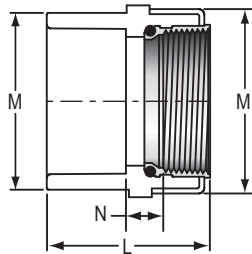

Part Number	Size	L	M	M1	N	Approx. Wt. (Lbs.)
4235-007	3/4	2	1-13/32	1-3/8	5/16	.23
4235-010	1	2-3/16	1-3/4	1-11/16	11/32	.25
4235-012	1-1/4	2-3/8	2-3/32	2-1/16	3/8	.36
4235-015	1-1/2	2-17/32	2-3/8	2-7/16	3/8	.47
4235-020	2	2-25/32	2-27/32	3-3/16	7/16	1.05

Not intended to convey or dispense water for human consumption through drinking or cooking

FEMALE ADAPTER

Special Reinforced Plastic Thread Style

Socket x SR Fipt

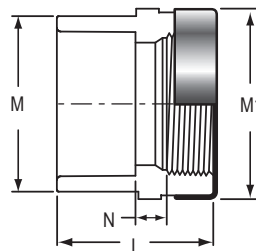

Part Number	Size	L	M	M1	N	Approx. Wt. (Lbs.)
4235-007SR	3/4	1-7/8	1-13/32	1-3/8	3/32	.08
4235-010SR	1	2-5/32	1-23/32	1-7/8	3/32	.22
4235-012SR	1-1/4	2-5/16	2-1/8	2-1/16	3/16	.20



FlameGuard® CPVC FIRE SPRINKLER PIPING PRODUCTS

FEMALE SPRINKLER HEAD ADAPTER Special Reinforced Plastic Thread Style

Socket x SR Fipt

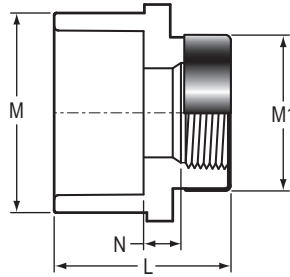

Part Number	Size	L	M	M1	N	Approx. Wt. (Lbs.)
4235-101SR	3/4x1/2	1-29/32	1-13/32	1-3/16	1/8	.08
4235-130SR	1x1/2	1-31/32	1-23/32	1-3/8	3/32	.16
4235-131SR	1x3/4	2-3/32	1-3/4	1-3/8	1/4	.13

FEMALE SPRINKLER HEAD ADAPTER Special Reinforced Plastic Thread Style with Socket Wrench Flats

Socket x SR Fipt

M = Flat-to-Flat Dimension

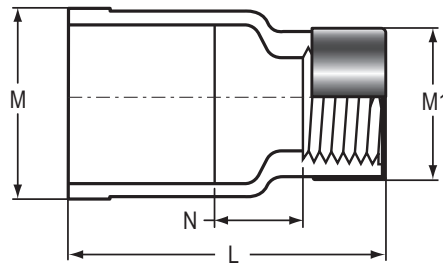

Part Number	Size	L	M	M1	N	Approx. Wt. (Lbs.)
W4235-101SR	3/4x1/2	2-9/32	1-13/32	1-3/16	17/32	.09
W4235-130SR	1x1/2	2-9/32	1-3/4	1-3/16	13/32	.12



SPIGOT FEMALE ADAPTER

Brass Thread Insert Style

Spigot x Fipt

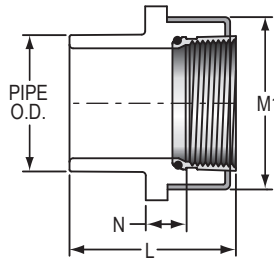

Part Number	Size	L	M1	N	Approx. Wt. (Lbs.)
4278-007	3/4	2-5/32	1-3/8	17/32	.15
4278-010	1	2-9/32	1-11/16	7/16	.22

Not intended to convey or dispense water for human consumption through drinking or cooking

SPIGOT FEMALE ADAPTER

Special Reinforced Plastic Thread Style

Spigot x SR Fipt

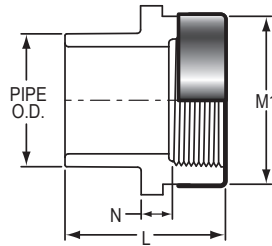

Part Number	Size	L	M1	N	Approx. Wt. (Lbs.)
4278-007SR	3/4	1-15/16	1-3/8	11/32	.08
4278-010SR	1	2-1/4	1-23/32	13/32	.13

TorqueSafe™ FEMALE SPRINKLER HEAD ADAPTER

Gasket Sealed Brass Thread Insert Style

Socket x Gasket Fipt

With Elastomer Seal - Use NO Thread Sealant

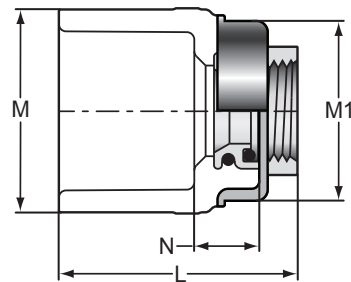

Part Number	Size	L	M	M1	N	Approx. Wt. (Lbs.)
4235-101 G	3/4x1/2	1-7/8	1-13/32	1-3/8	9/16	.15
4235-130GS	1x1/2	2-1/32	1-11/16	1-3/8	17/32	.17
4235-131 G	1x3/4	2	1-11/16	1-9/16	9/16	.18

Not intended to convey or dispense water for human consumption through drinking or cooking



FlameGuard® CPVC FIRE SPRINKLER PIPING PRODUCTS

FEMALE SPRINKLER HEAD ADAPTER

Brass Thread Insert Style

Socket x Fipt

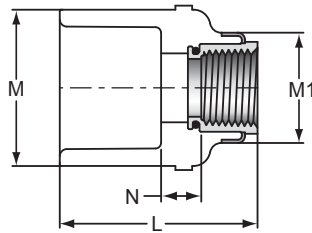

Part Number	Size	L	M	M1	N	Approx. Wt. (Lbs.)
4235-101	3/4x1/2	1-7/8	1-13/32	1-17/32	15/32	.19
4235-130	1x1/2	2-11/32	1-11/16	1-3/16	5/8	.16
4235-131	1x3/4	2-5/16	1-11/16	1-3/8	17/32	.18

Not intended to convey or dispense water for human consumption through drinking or cooking

SofTorque™ SR FEMALE SPRINKLER HEAD ADAPTER

Gasket Sealed Special Reinforced Plastic Thread Style

Socket x SR Fipt

With Elastomer Seal - Use NO Thread Sealant

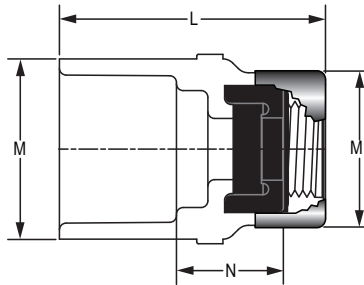

Part Number	Size	L	M	M1	N	Approx. Wt. (Lbs.)
4235-101GSR	3/4x1/2	2-5/16	1-5/16	1-3/8	31/32	.11
4235-130GSR	1x1/2	2-13/32	1-19/32	1-3/8	31/32	.13
4235-131GSR	1x3/4	2-13/32	1-5/8	1-23/32	1	.16

QuickTorque™ SR FEMALE SPRINKLER HEAD ADAPTER

Gasket Sealed Special Reinforced Plastic Thread Style

Socket x SR Metal Fipt

With Elastomer Seal - Use NO Thread Sealant

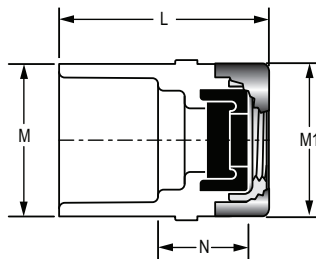

Part Number	Size	L	M	M1	N	Approx. Wt. (Lbs.)
4235-101GMR	3/4x1/2	1-15/16	1-5/16	1-9/16	13/16	.17
4235-130GMR	1x1/2	2-3/16	1-19/32	1-9/16	15/16	.19



FEMALE SPRINKLER HEAD ADAPTER Brass Thread Insert Style with Long Body

Socket x Fipt

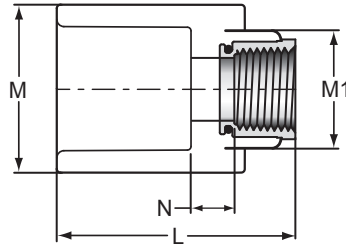

Part Number	Size	L	M	M1	N	Approx. Wt. (Lbs.)
L4235-130	1x1/2	2-3/16	1-23/32	1-7/32	1/2	.19

Not intended to convey or dispense water for human consumption through drinking or cooking

FEMALE SPRINKLER HEAD ADAPTER Brass Thread Insert Style with Positioning Ring

Socket x Fipt

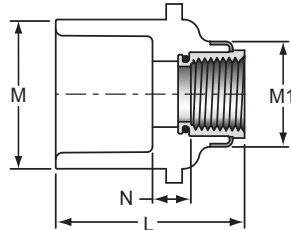

Part Number	Size	L	M	M1	N	Approx. Wt. (Lbs.)
R4235-101	3/4x1/2	2-1/32	1-7/16	1-3/16	15/32	.15

Not intended to convey or dispense water for human consumption through drinking or cooking

FEMALE SPRINKLER HEAD ADAPTER Special Reinforced Plastic Thread Style with Positioning Ring

Socket x SR Fipt

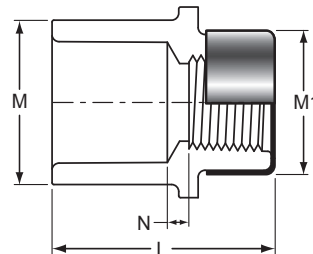

Part Number	Size	L	M	M1	N	Approx. Wt. (Lbs.)
R4235-101SR	3/4x1/2	1-15/16	1-7/16	1-7/32	7/32	.09

TorqueSafe™ FEMALE SPIGOT SPRINKLER HEAD ADAPTER Gasket Sealed Brass Thread Insert Style

Spigot x Gasket Fipt

With Elastomer Seal - Use NO Thread Sealant

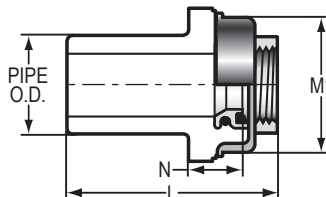

Part Number	Size	L	M	N	Approx. Wt. (Lbs.)
4238-101 G	3/4x1/2	1-15/16	1-3/8	21/32	.14
4238-130 G	1x1/2	2-1/16	1-3/8	19/32	.15

Not intended to convey or dispense water for human consumption through drinking or cooking



FlameGuard® CPVC FIRE SPRINKLER PIPING PRODUCTS

SPIGOT FEMALE SPRINKLER HEAD ADAPTER

Brass Thread Insert Style

Spigot x Fipt

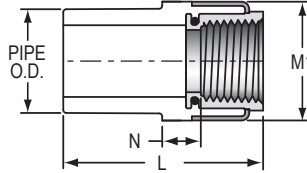

Part Number	Size	L	M1	N	Approx. Wt. (Lbs.)
4238-101	3/4x1/2	1-15/16	1-17/32	17/32	.18
4238-130	1x1/2	2-1/4	1-3/16	11/32	.19

Not intended to convey or dispense water for human consumption through drinking or cooking

TorqueSafe™ BUSHING - GASKET SEALED

Brass Thread Insert Style

Spigot x Gasket FIPT

With Elastomer Seal - Use NO Thread Sealant

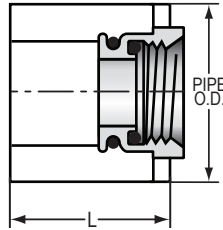

Part Number	Size	L	Approx. Wt. (Lbs.)
4238-130BR G	1x1/2	1-7/32	.10

Not intended to convey or dispense water for human consumption through drinking or cooking

BUSHING with BRASS THREAD INSERT

Spigot x Fipt

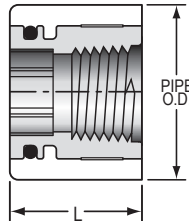

Part Number	Size	L	Approx. Wt. (Lbs.)
4238-130BR	1x1/2	1	.13

Not intended to convey or dispense water for human consumption through drinking or cooking

SPIGOT FEMALE SPRINKLER HEAD ADAPTER

Special Reinforced Plastic Thread Style

Spigot x SR Fipt

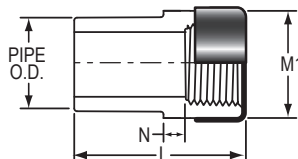

Part Number	Size	L	M1	N	Approx. Wt. (Lbs.)
4238-101SR	3/4x1/2	1-29/32	1-7/32	1/8	.07
4238-130SR	1x1/2	2-1/32	1-7/32	7/32	.09

FlameGuard® CPVC FIRE SPRINKLER PIPING PRODUCTS



MALE ADAPTER

With CPVC Lined Thread Brass Insert
Mipt x Socket

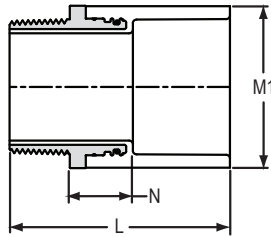

Part Number	Size	L	M1	N	Approx. Wt. (Lbs.)
4236-007	3/4	2-17/32	1-13/32	13/16	.26
4236-010	1	2-15/16	1-23/32	29/32	.43
4236-012	1-1/4	3-1/8	2-3/32	31/32	.66
4236-015	1-1/2	3-9/32	2-11/32	31/32	.80
4236-020	2	3-7/16	2-27/32	31/32	1.00

ADJUSTABLE SPRINKLER HEAD ADAPTER

Special Reinforced Plastic Thread Style

Socket x SR Fipt

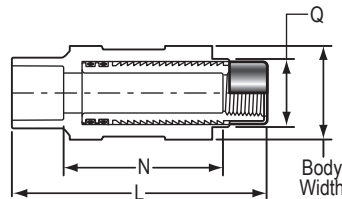

Part Number	Size	L		N		Q	Body Width	Approx. Wt. (Lbs.)
		Min	Max	Min	Max			
42001SR	3/4x1/2	6-9/32	8	4-7/16	6-1/4	1-7/16	2-3/16	.66
42011SR	1x1/2	6-13/32	8	4-1/2	6-1/8	1-7/16	2-1/8	.68

ADJUSTABLE SPRINKLER HEAD ADAPTER

Special Reinforced Plastic Thread Style

Spigot x SR Fipt

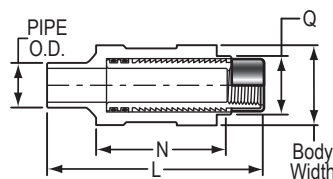

Part Number	Size	L		N		Q	Body Width	Approx. Wt. (Lbs.)
		Min	Max	Min	Max			
42004SR	3/4x1/2	5-1/32	6-5/16	3-3/16	4-15/32	1-5/16	2-1/8	.36
42014SR	1x1/2	6-7/16	8-1/8	4-7/16	6-1/4	1-7/16	2-3/16	.67



FlameGuard® CPVC FIRE SPRINKLER PIPING PRODUCTS

REDUCER BUSHING

Flush Style
Spigot x Socket

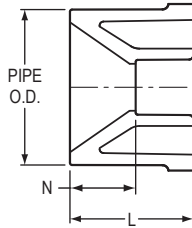

Part Number	Size	L	N	Approx. Wt. (Lbs.)
4237-131	1x3/4	1-1/4	1/4	.04
4237-167	1-1/4x3/4	1-7/16	7/16	.10
4237-168	1-1/4x1	1-13/32	9/32	.06
4237-210	1-1/2x3/4	1-5/8	5/8	.19
4237-211	1-1/2x1	1-17/32	13/32	.13
4237-212	1-1/2x1-1/4	1-9/16	5/16	.07
4237-248	2x3/4	1-29/32	29/32	.28
4237-249	2x1	1-23/32	9/16	.23
4237-250	2x1-1/4	1-11/16	7/16	.21
4237-251	2x1-1/2	1-11/16	5/16	.15
4237-290	2-1/2x1-1/4	2-5/32	7/8	.41
4237-291	2-1/2x1-1/2	2-5/32	3/4	.39
4237-292	2-1/2x2	2-9/32	3/4	.28
4237-338	3x2	2-7/32	11/16	.63
4237-339	3x2-1/2	2-5/16	1/4	.42

TRANSITION BUSHING

IPS Spigot x CTS Socket

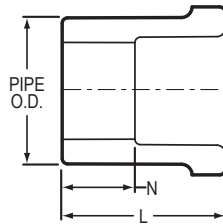

Part Number	Size	L	N	Approx. Wt. (Lbs.)
4240-101	3/4x1/2	1-1/8	5/8	.03
4240-130	1x1/2	1-1/4	23/32	.05

CAP

Socket

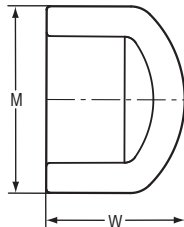

Part Number	Size	M	W	Approx. Wt. (Lbs.)
4247-007	3/4	1-5/16	1-5/16	.04
4247-010	1	1-5/8	1-9/16	.06
4247-012	1-1/4	2-3/32	1-27/32	.13
4247-015	1-1/2	2-11/32	2	.17
4247-020	2	2-27/32	2-9/32	.39
4247-025	2-1/2	3-17/32	2-5/8	.50
4247-030	3	4-3/8	3	.92



TEST PLUG - O-ring Sealed

Mipt - For Pressure Testing Only,
Not For use with Z4235 Series Adapters

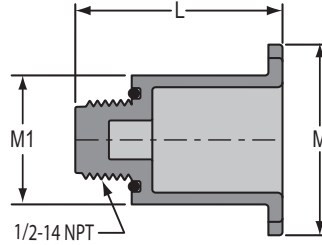

Part Number	Size	L	M	M1	Approx. Wt. (Lbs.)
FTP-005	1/2	1-27/32	1-15/16	1-7/32	.03

TEST PLUG for TorqueSafe™ Gasket Sealed Head Adapters

Mipt - For Pressure Testing Only.
Use ONLY with Gasket Sealed Head Adapters

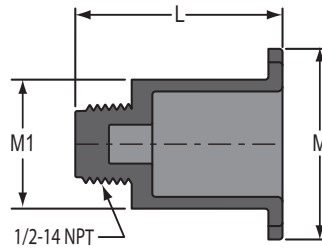

Part Number	Size	L	M	M1	Approx. Wt. (Lbs.)
FTP-005GS	1/2	1-25/32	2-1/32	1-1/4	.05

TEST PLUG

(PVC White) Not UL Listed; For Pressure Testing Only,
Mipt

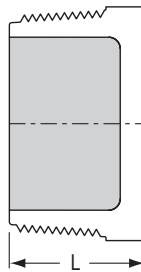

Part Number	Size	L	Approx. Wt. (Lbs.)
4250-005	1/2	27/32	.02



FlameGuard® CPVC FIRE SPRINKLER PIPING PRODUCTS

FLANGE - ONE PIECE

4 Bolt Holes, 175 psi
Socket

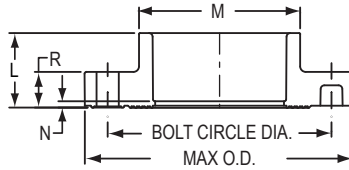

Part Number	Size	L	M	N	R	No. of Bolt Holes	Bolt Circle Dia.	Bolt Size	Min. Bolt Length	Max. O.D.	Approx. Wt. (Lbs.)
4251-007	3/4	1-5/32	1-1/2	1/8	17/32	4	2-3/4	1/2	2	3-29/32	.31
4251-010	1	1-5/16	1-13/16	1/8	11/16	4	3-1/8	1/2	2-1/4	4-9/32	.35
4251-012	1-1/4	1-13/32	2-7/32	5/32	11/16	4	3-1/2	1/2	2-1/4	4-5/8	.44
4251-015	1-1/2	1-19/32	2-1/2	3/16	23/32	4	3-27/32	1/2	2-1/2	5-1/16	.61
4251-020	2	1-27/32	3	5/16	27/32	4	4-3/4	5/8	3	5-31/32	.95
4251-025	2-1/2	2-7/32	3-1/2	7/16	1-1/32	4	5-1/2	5/8	3-1/4	7	1.50

BLIND FLANGE

4 Bolt Holes, 175 psi

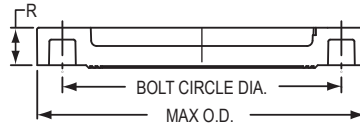

Part Number	Size	R	Bolt Circle Dia.	No. of Bolt Holes	Bolt Size	Min. Bolt Length	Max. O.D.	Approx. Wt. (Lbs.)
4253-007	3/4	17/32	2-3/4	4	1/2	2	3-27/32	.30
4253-010	1	23/32	3-1/8	4	1/2	2-1/4	4-1/4	.35
4253-012	1-1/4	21/32	3-1/2	4	1/2	2-1/4	4-5/8	.40
4253-015	1-1/2	23/32	3-27/32	4	1/2	2-1/2	5-1/16	.52
4253-020	2	27/32	4-3/4	4	5/8	3	5-31/32	.86
4253-025	2-1/2	1-1/32	5-1/2	4	5/8	3-1/4	6-15/16	1.70
4253-030	3	1-5/16	6	4	5/8	3-1/4	7-5/8	1.72

FLANGE - TWO PIECE

Van Stone Style, 4 Bolt Holes, 175 psi
Socket

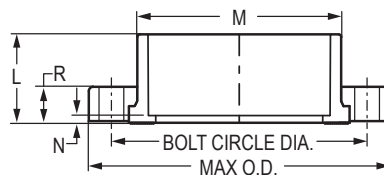

Part Number	Size	L	M	N	R	Bolt Circle Dia.	No. of Bolt Holes	Bolt Size	Min. Bolt Length	Max. O.D.	Approx. Wt. (Lbs.)
4254-030	3	2-1/8	4-1/4	9/32	1-1/32	6	4	5/8	3-1/4	7-15/32	1.75

FlameGuard® CPVC FIRE SPRINKLER PIPING PRODUCTS



FLANGE - TWO PIECE

Van Stone Style, 4 Bolt Holes, 175 psi
Spigot

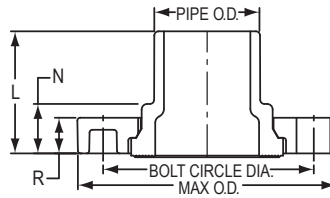

Part Number	Size	L	N	R	Bolt Circle Dia.	No. of Bolt Holes	Bolt Size	Min. Bolt Length	Max. O.D.	Approx. Wt. (Lbs.)
4256-007	3/4	1-15/16	13/16	17/32	2-3/4	4	1/2	2	3-27/32	.30
4256-010	1	2-7/32	1-1/32	11/16	3-1/8	4	1/2	2-1/4	4-1/4	.41
4256-012	1-1/4	2-3/8	1	11/16	3-1/2	4	1/2	2-1/4	4-5/8	.50
4256-015	1-1/2	2-7/16	1-3/32	23/32	3-7/8	4	1/2	2-1/2	4-31/32	.65
4256-020	2	2-3/4	1-5/32	25/32	4-3/4	4	5/8	3	5-15/16	1.00
4256-025	2-1/2	3-1/16	1-9/32	1-1/32	5-1/2	4	5/8	3-1/4	6-15/16	1.62
4256-030	3	3-3/8	1-13/32	1-1/32	6	4	5/8	3-1/4	7-9/16	1.76

TRANSITION UNION

Brass Thread Insert Style

Socket x Fipt

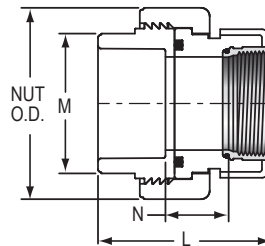

175 psi

Part Number	Size	L	M	N	Nut O.D.	Approx. Wt. (Lbs.)
4259-010BR	1	2-13/16	1-7/8	1-1/32	2-7/8	.52
4259-012BR	1-1/4	3	2-3/16	1-1/8	3-9/32	.98
4259-015BR	1-1/2	3-3/4	2-1/2	1-9/16	3-17/32	.93
4259-020BR	2	3-5/8	2-7/8	1-1/4	4-5/16	1.64

Not intended to convey or dispense water for human consumption through drinking or cooking

UNION

Socket x Socket

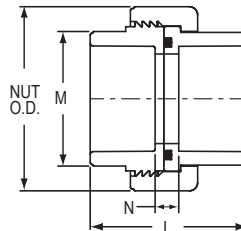

175 psi

Part Number	Size	L	M	N	Nut O.D.	Approx. Wt. (Lbs.)
4257-007	3/4	2-3/8	1-17/32	3/8	2-1/2	.38
4257-010	1	2-9/16	1-27/32	3/8	2-7/8	.41
4257-012	1-1/4	2-27/32	2-7/32	11/32	3-5/16	.52
4257-015	1-1/2	3-1/8	2-1/2	3/8	3-17/32	.63
4257-020	2	3-5/8	3-1/32	9/16	4-3/16	1.09



FlameGuard® CPVC FIRE SPRINKLER PIPING PRODUCTS

SofTorque™ SR FEMALE SPIGOT SPRINKLER HEAD ADAPTER

Gasket Sealed Special Reinforced Plastic Thread Style

Spigot x SR Fipt
With Elastomer Seal - Use NO Thread Sealant

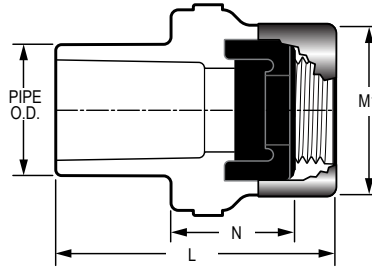

Part Number	Size	L	M1	N	Approx. Wt. (Lbs.)
4278-101GSR	3/4x1/2	2-1/4	1-3/8	1	.11

SHORT REPAIR COUPLING

Spigot x Socket

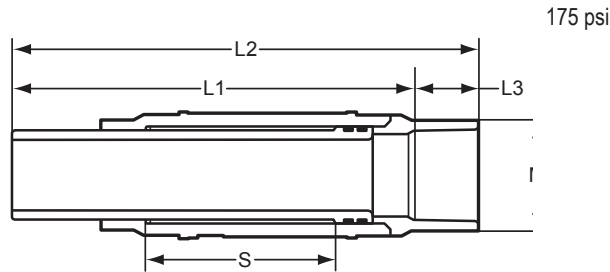

Part Number	Size	L1	L2	L3	M	S	Approx. Wt. (Lbs.)
SH118-07CO	3/4	4-13/16	5-17/32	3/4	1-3/4	2-3/16	.31
SH118-10CO	1	4-3/4	5-5/8	31/32	2-1/16	2-5/32	.40

GripLoc™ REPAIR COUPLING – LEAD FREE

w/EPDM O-Ring Seals

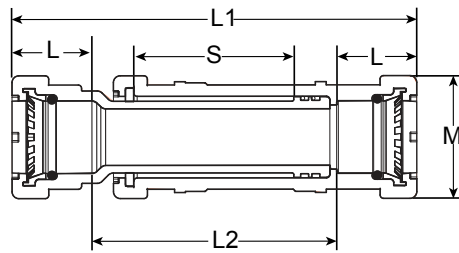

175 psi Maximum Pressure @ 150°F

WARNING: DO NOT INSERT FINGERS.

Part Number	Size	L	L1	L2	M	S	Approx. Wt. (Lbs.)
SG118-10CO	1	1-17/32	7-17/32	4-1/4	2-1/4	2-27/32	.73



FlameGuard® CPVC Drain & Swing Check Valves for NFPA 13D Applications Only

Application: FlameGuard® CPVC Orange Swing Check Valves and PVC/CPVC True Union Drain Valves are for use in configuring CPVC Fire Sprinkler System connection to water supply (riser/drain assembly) in NFPA 13D installations only. These valves are not UL Listed and NOT for use in any other locations within the fire sprinkler system.

TRUE UNION INDUSTRIAL DRAIN VALVES CPVC Gray Valve with CPVC Orange End Connector Socket x Socket

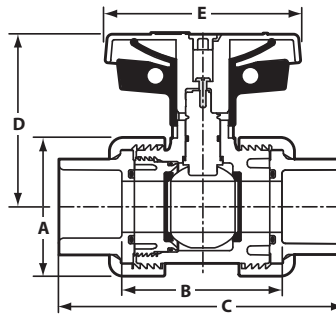

Part Number	Size	A	B	C	D	E
1822-007CFG	3/4	2-1/4	2-3/4	4-3/4	2-7/8	3-3/8
1822-010CFG	1	2-1/2	2-7/8	5-1/8	3-1/8	3-7/16
1822-012CFG	1-1/4	3-1/16	3-1/4	5-3/4	3-5/8	3-7/8
1822-015CFG	1-1/2	3-1/2	3-1/2	6-1/4	4	4-3/16
1822-020CFG	2	4-1/4	4-3/4	7-3/4	4-1/2	5-1/8

Not UL Listed

TRUE UNION DRAIN VALVES PVC Valve with CPVC End Connector Socket x Socket

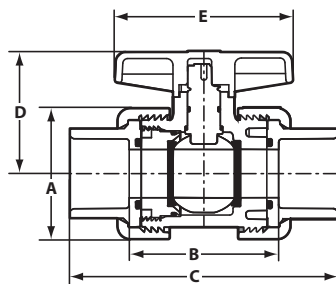

Part Number	Size	A	B	C	D	E
3622-007FG	3/4	2-1/4	2-3/4	4-3/4	2	3
3622-010FG	1	2-1/2	2-7/8	5-1/8	2-5/16	3-7/16

Not UL Listed



FlameGuard® CPVC FIRE SPRINKLER PIPING PRODUCTS

COMPACT 2000 DRAIN VALVE

Socket x Socket

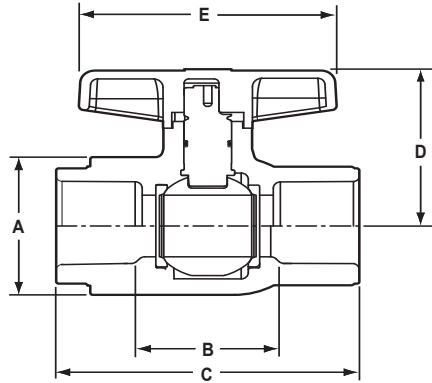

Part Number	Size	A	B	C	D	E
6622-007CO	3/4	1-13/16	1-1/2	3-9/16	2	3
6622-010CO	1	2-1/16	1-3/4	4	2-5/16	3-7/16

Not UL Listed

CPVC SWING CHECK VALVES

Socket x Socket

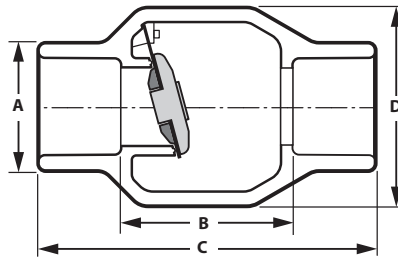

Part Number	Size	A	B	C	D	Approx. Wt. (Lbs)
S1520-10CO	1	1-11/16	2-5/16	4-9/16	2-5/8	.33
S1520-12CO	1-1/4	2-1/16	2-15/16	5-1/2	3-3/8	.42
S1520-15CO	1-1/2	2-7/16	3	5-5/8	3-3/8	.89

Not UL Listed

CPVC SPECIAL REINFORCED THREAD INLET SWING CHECK VALVES

SR Fipt x Socket

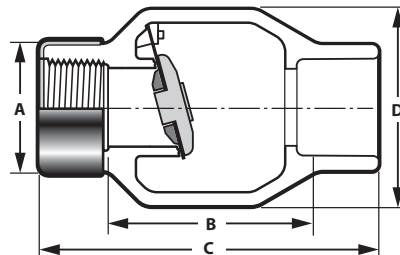

Part Number	Size	A	B	C	D	Approx. Wt. (Lbs)
S1520-10FSRSCO	1	1-11/16	2-15/16	4-9/16	2-5/8	.33
S1520-12FSRSCO	1-1/4	2-1/16	3-5/8	5-1/2	3-3/8	.42
S1520-15FSRSCO	1-1/2	2-7/16	3-11/16	5-5/8	3-3/8	.89

Not UL Listed

PRODUCT LIMITED LIFETIME WARRANTY



Except as otherwise specified for certain products, mandated by law or herein provided, Spears® Manufacturing Company ("Company") warrants Standard Catalog Products ("Products") which have been directly manufactured by them to be free from defects in material and workmanship for as long as the original intended end user of the Products ("End User") retains ownership and possession of the Products and complies with this Warranty ("Warranty Period"). Each other person or entity acquiring or employing the Products, including buyers, contractors and installers ("Buyer") and End Users ("Buyer/End User") agrees that this Warranty shall be effective only during the Warranty Period so long as the Products are used solely for the normal purposes for which they are intended and in conformance with industry established standards, engineering, installation, operating, and maintenance specifications, recommendations and instructions including explicit instructions by the Company; the Products are properly installed, operated and used, and have not been modified; and all the other terms of this Warranty are complied with. Any violation thereof shall void this Warranty and relieve Company from all obligations arising from this Warranty and the Products.

Upon receipt or discovery of any Products that appear questionable or defective each Buyer/End User shall promptly inspect and return any such Product to the Company at 15853 Olden Street, Sylmar, California 91342, accompanied by a letter stating the nature of any problems. If the Products are determined by Company to be defective in materials or workmanship directly provided by Company, Company, at its sole option, may either repair or replace the defective Products, or reimburse applicable Buyer/End User for the cost of such Products. The applicable Buyer/End User shall bear all applicable shipping costs. THIS SHALL BE BUYERS/END USERS' SOLE REMEDY. EACH BUYER/END USER AGREES THAT COMPANY WILL NOT BE RESPONSIBLE FOR ANY OTHER OBLIGATIONS RELATING TO THE PRODUCTS, INCLUDING ANY OTHER MATERIALS OR LABOR COSTS, LOSS OF USE OR ANY OTHER ITEM OR FOR ANY DELAYS IN COMPLYING WITH THIS WARRANTY BEYOND COMPANY'S REASONABLE CONTROL.

COMPANY SHALL NOT BE LIABLE FOR, DOES NOT ASSUME, AND EXPRESSLY DISCLAIMS, ANY LIABILITY, RESPONSIBILITY AND DAMAGES: DUE TO ANY BUYER/END USER'S FAILURE TO COMPLY WITH THIS WARRANTY, INCLUDING IMPROPER INSTALLATION, USE OR OPERATION; USE WITH PRODUCTS FROM OTHER MANUFACTURERS THAT DO NOT MEET ASTM OR OTHER APPLICABLE PRODUCT STANDARDS; IMPROPER CONTROL OF SYSTEM HYDRAULICS, IMPROPER WINTERIZATION PROCEDURES, IMPROPER VOLTAGE SUPPLY, CONTACT WITH INCOMPATIBLE MATERIALS OR CHEMICALS, EXCAVATION/DIGGING, EXCESSIVE WEIGHT, AND VANDALISM; DUE TO REASONABLE WEAR AND TEAR AND DUE TO ANY ACTS OF NATURE, INCLUDING LIGHTNING, EARTHQUAKES, GROUND MOVEMENT, FROST HEAVE, OR FLOODS.

COMPANY EXTENDS ONLY THIS WARRANTY AND EXPLICITLY DISCLAIMS ALL OTHER WARRANTIES, WHETHER IMPLIED OR OTHERWISE EXPRESSED, WHETHER ORAL, STATUTORY OR OTHERWISE, INCLUDING ANY IMPLIED WARRANTIES OR AFFIRMATIONS FOR SUITABILITY, MERCHANTABILITY OR FITNESS FOR A PARTICULAR PURPOSE. NO AFFIRMATION BY COMPANY OR ANY OF ITS REPRESENTATIVES, BY WORDS, CONDUCT OR OTHERWISE, SHALL CONSTITUTE A WARRANTY. THIS WARRANTY MAY NOT BE TRANSFERRED, EXTENDED, ALTERED OR OTHERWISE MODIFIED IN ANY MANNER, EXCEPT BY WRITTEN AGREEMENT SIGNED BY COMPANY.

BY ITS ACCEPTANCE OF THE PRODUCTS, EACH BUYER/END USER EXPRESSLY WAIVES ALL OTHER LIABILITY OR OBLIGATION OF ANY KIND OR CHARACTER OF COMPANY, INCLUDING LIABILITY PREDICATED UPON CONTRACT, TORT, STRICT LIABILITY OR OTHER LEGAL OR EQUITABLE GROUNDS, AND ALL, IF ANY, DAMAGES AND LOSSES AS A RESULT THEREOF, INCLUDING ALL, IF ANY, COMPENSATORY, GENERAL, SPECIAL, CONSEQUENTIAL, INCIDENTAL, OR PUNITIVE DAMAGES. WITH RESPECT TO SUCH WAIVERS, EACH BUYER/END USER EXPLICITLY WAIVES CALIFORNIA CIVIL CODE §1542 WHICH STATES "A GENERAL RELEASE DOES NOT EXTEND TO CLAIMS WHICH THE CREDITOR DOES NOT KNOW OR SUSPECT TO EXIST IN HIS FAVOR AT THE TIME OF EXECUTING THIS RELEASE, WHICH IF KNOWN BY HIM MUST HAVE MATERIALLY ADVERSELY AFFECTED HIS SETTLEMENT WITH DEBTOR" AND ALL OTHER SIMILAR STATUTORY, COMMON AND CASE LAW RIGHTS, DEFENSES AND LIMITATIONS.

Having previously independently inspected the Products, or a sample, as fully as desired, or having the opportunity to and having not done so, upon acceptance of delivery of the Products, and except as otherwise herein explicitly provided, each Buyer/End User by acceptance or use of the Products accepts them in their "AS IS" and "WITH ALL FAULTS" condition without any other warranty, expressed, implied or otherwise, and accepts and assumes the entire risk and cost of all servicing, remediation and consequences thereof. This Warranty shall be governed by California law and any unenforceable provisions severed without affecting the remaining provisions. As used herein, "including" includes "without limitation."

Spears® Quality Policy

It is the policy and objective of Spears® Manufacturing Company to produce a superior quality product suitable for its intended use, with regard to functionality, structural integrity and conformance to established industry standards and practices. It is the commitment of this Company to do so in a manner which provides consistency of product quality, optimum availability, and superior customer service, while maintaining efficiency of operations and profitability necessary to perpetuate product improvement and customer satisfaction. Furthermore, it is recognized that the attainment of these objectives is the responsibility of all Company operations and personnel according to their respective functions.

The information contained in this publication is based on current information and product design at the time of publication and is subject to change without notification. Our ongoing commitment to product improvement may result in some variations. No representations, guarantees or warranties of any kind are made as to its accuracy, suitability for particular application or results to be obtained therefrom. For information not contained herein, please contact Spears® Technical Services Department [West Coast: (818) 364-1611 — East Coast: (678) 985-1263]. Reproduction of this publication in whole or in part is prohibited without the authorized consent of Spears® Manufacturing Company, Sylmar, California.



SPEARS® MANUFACTURING COMPANY

Corporate Office
15853 Olden Street • Sylmar, CA 91342
PO Box 9203 • Sylmar, CA 91392
(818) 364-1611 • <http://www.spearsmfg.com>

